



Networked Robotics Corporation
4900 Hopyard Rd Suite 100
Pleasanton, CA 94588. USA
Toll free (877) FRZ-TEMP
(877) GLP-TEMP

info@networkedrobotics.com
support@networkedrobotics.com

NetworkedRobotics.com

Dry Contact Probe DCP (#30008)

The Networked Robotics DCP probe enables network data collection of the state of any normally open or normally closed switch. This product can sense alarm contact outputs on freezers, incubators, environmental monitoring systems, gas analyzers, and many other kinds of electronic scientific instruments and sensors. It can also read the state of physical switches like pushbuttons, emergency switches, or door sensors. The DCP is designed to be used as part of the Tempurity™ System for remote data collection in real-time via standard computer networks. The interface is used in conjunction with the Networked Robotics NTMS (Network Telemetry Monitoring System) hardware and Networked Robotics Tempurity software. The Tempurity System is designed for data collection and monitoring in FDA-regulated environments.

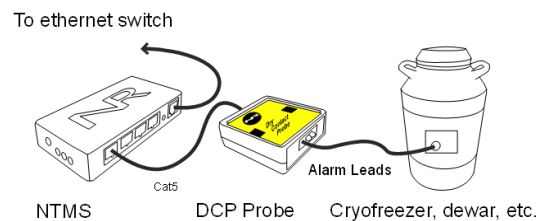

Description

One side of the DCP connects to one of the Networked Robotics NTMS (Network Telemetry Monitoring System) hardware probe ports, and the other side connects to the alarm contact outputs of a scientific instrument or other types of electronic instrument or switch.

When the NTMS polls the DCP, it returns one of two numeric values or an error, depending on the state of the contacts. One value represents the “normal” condition, and the other represents the “alarm” condition. The Tempurity Server continually collects this status value through the network and stores the value on the Tempurity Server computer. E-mail, text, and phone are available when an alarm condition is detected.

This product is the most generally applicable of all Networked Robotics’ data collection interfaces. Most scientific instruments have alarm contact outputs. However it also provides the least information with only Boolean (yes/no) information on whether an aberrant condition exists rather than providing fully trending data as is the case for many of our other scientific network data collection products.

Packing List

This package includes the basic hardware you will need to connect the Dry Contact Probe (DCP) to the NTMS. Because of the wide variety of monitored device types to which this DCP can be connected, the customer may require additional cabling and connectors. The interface cabling is most commonly 3 wires with stripped ends attached to terminal blocks however the customer should consult the manual for their monitored device (cryofreezer, incubator, etc.) and/or call Networked Robotics to determine the location of the dry contacts, and the required connector type. Examples of some types of connections are included in the appendixes of this manual.

- (1) Dry Contact Probe
- (1) Set of 3 alarm contact wires
- (1) CAT5e cable
- (1) RJ45 coupler

Some DCP shipments will include special interface wiring for connection to specific instrumentation.

Collection from Multiple Monitored Devices

Each NTMS4 unit has 4 measurement ports. Any combination of Networked Robotics' data collection methods can be used on those ports. Data from 4 DCPs or any combination of DCPs and Networked Robotics digital sensors or direct connections to high-end scientific equipment can be implemented simultaneously. Only a single monitored device, via a single DCP, is shown in the figure above. See other Networked Robotics hardware manuals for descriptions of how to enable network-based data collection from our other types of equipment.

Factory Setting for Normal and Alarm Values

Two "artificial" values are selected to indicate normal and alarm readings. The standard DCP firmware, because these units are often used for monitoring liquid nitrogen environments is -196° Celsius for normal and 0° Celsius for alarm. This is true regardless of what you are monitoring. A "normal" door-closed indication is -196 and an "error" or open-door indication is 0. You can describe the type of connection in the Tempurity System. Door status can be listed as "door status" for example. Thus value thresholds in the Tempurity System should be set to a -197 low temperature and a -195 high temperature, or any range including -196 but not 0.

Other Products

The use of the DCP interface tells you that there is a problem, but depending on the instrumentation's implementation usually not the specific problem or how severe it is. For more detailed information consider using other Networked Robotics products for data collection, such as our digital sensors, third party analog sensors via our Low Voltage Probe or our direct connections to high-end scientific instruments.

Hardware Installation

There are three major steps in the installation of this hardware

- 1) Physical installation
- 2) Configuration of the Networked Robotics NTMS hardware to which the DCP is attached
- 3) Manual testing of data collection via the network

Each of these steps should be performed successfully before attempting to configure and monitor real-time data via the Tempurity System. Detailed information on configuring data collection in Tempurity is available in the Tempurity Systems User's Guide (Networked Robotics document number "Tempurity-04-0006.5)" on the Networked Robotics web site.

1. Physical Installation

The cable type used in the connection of the DCP to the monitored device, the freezer, incubator, cryofreezer, etc., will be variable as this will depend on the format of the alarm contact connector. This is usually located on the back of the instrument. Examine your instrument and/or the manufacturer's documentation for the normally open and normally closed contacts before proceeding. This product works best when there are two mutually exclusive outputs represented by three pins on the monitored device output – N.O. or Normally Open and C or Common, and N.C. or Normally Closed – which shares the Common pin.

Some instrument implementations utilize only two pins, either N.O. or N.C. and Common or Ground. This type of output also works with this product.

Turn the DCP over and remove the two screws on the back, which hold the case together.

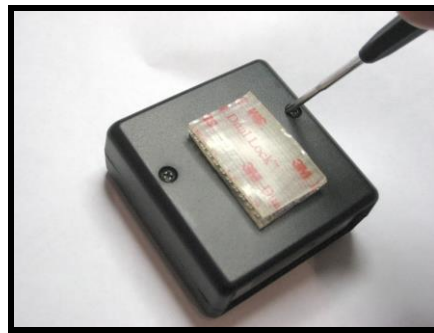

Next locate the blue three position screw terminals at the bottom of the board. The diagram and table below show how the DCP should be connected. When the monitored device provides continuity between pin #2 (common) and pin #3 (normal), the DCP will assume the monitored device is operating normally and report the “normal” temperature to the NTMS. When the monitored device provides continuity between pin #2 (common) and pin #3 (error), the DCP will report the “error” temperature. If there is no continuity present between either set (#2 to #1, or #2 to #3), then the DCP will not respond and the Tempurity system will indicate a “Communications Error”.

If your monitored device has only two pins rather than three, you will need to connect more than one wire to some of the DCP pins in the blue connector block.

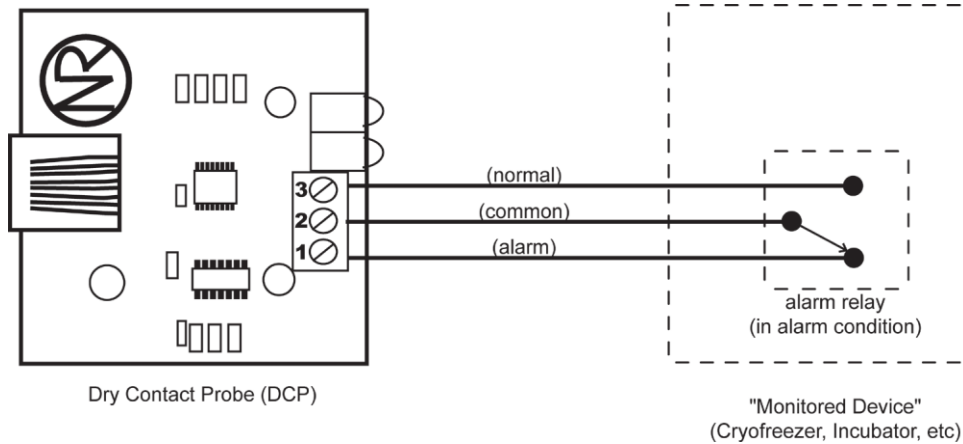

Condition between Pins 1 (alarm) & 2 (common)	Condition between Pins 2 (common) & 3 (normal)	DCP Reports
Connected	Open	Alarm temperature
Open	Connected	Normal temperature
Open	Open	Communications Error
Connected	Connected	Alarm temperature

The screw terminals can accommodate 22 to 14 AWG wire. To connect, strip approximately 1/4" of insulation from the wire, insert into the screw terminal, and tighten down with a small flat head screwdriver. Typically 18 or 20 AWG industrial automation/process control cable would be used. If the cable has a shield, or extra conductors, do not connect them to the DCP. Verify that no exposed wire is touching another wire.

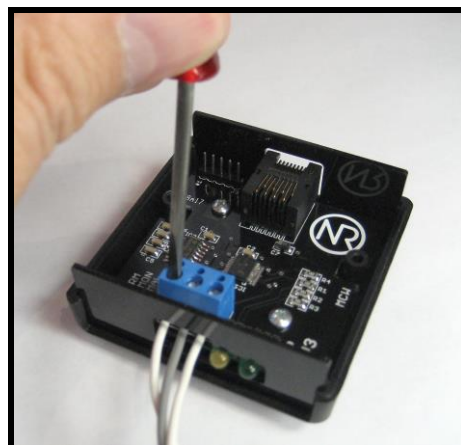

Replace the cover and its screws to close the DCP. Then use the provided CAT5E cable to connect the DCP to any of the four probe ports on the NTMS. If needed, you can use a longer length of CAT5 cable. The maximum distance, however, should not exceed 100 meters.



If the NTMS is powered up, and the CAT5E cable connection is made correctly between the DCP and the NTMS, the yellow LED on the DCP will illuminate and blink quickly ten times.

The other LED indicates the current state of the normal dry contacts. When the “normal” terminal has continuity with the “common” terminal the green LED will illuminate. If needed, it is possible to verify this by connecting a short jumper between the screw terminals. When the contacts are connected together, the green LED comes on.



Secure the DCP to a convenient location using the dual-lock provided on the back of the DCP. The dual-lock adheres to metal or plastic surfaces. It is not designed to adhere to porous surfaces such as drywall or wood.

Connecting to Instruments with Two vs. Three Output Pins

There are generally two types of alarm contact outputs on scientific instruments or any kind of electronics with this type of output: two-pin and three-pin. The three-pin interfaces always include N.O., Common, and N.C. The two-pin interfaces are either N.O. and Common, or N.C. and Common. The label near the connector often tells you which one is in use. If there is no label then consult the manual for the instrument.

See the connection condition table above. In the three-pin case the three wires are each connected to one of the three pins with the instrument’s Common connected to pin 2, instrument N.O. to pin 1, and instrument N.C. to pin 3.

If the device you want to monitor only has two pins (alarm and common), then connect the instrument outputs to pins 1 & 2, and use a small jumper to connect pins 2 & 3. Set the Tempurity System’s allowable ranges as appropriate for the connection.

Extensions

The DCP can be extended up to 300 feet from the Networked Robotics NTMS network hardware. You can easily extend the length of any connection using the included RJ-45 coupler and standard CAT5 network cable.

2. Configuring the NTMS

Configure your NTMS network hardware for data collection from this instrument. This is done by running the latest version of the NTMS Configuration Wizard  from any PC that is on the same subnet as the NTMS to be configured. You can obtain the configuration wizard from the “download” section of the Networked Robotics web page. See <http://www.NetworkedRobotics.com/download>.

New sensor and interface types are being added periodically to the wizard so the screens below may change.

1. Run the wizard from the same local area network as the NTMS and verify that the NTMS is discovered. (NTMS hardware must be running firmware revision 1.6 or higher. If it is not, stop the installation and upgrade your

NTMS hardware's firmware with the NTMS Upgrade Wizard  available from the Networked Robotics download-page.)

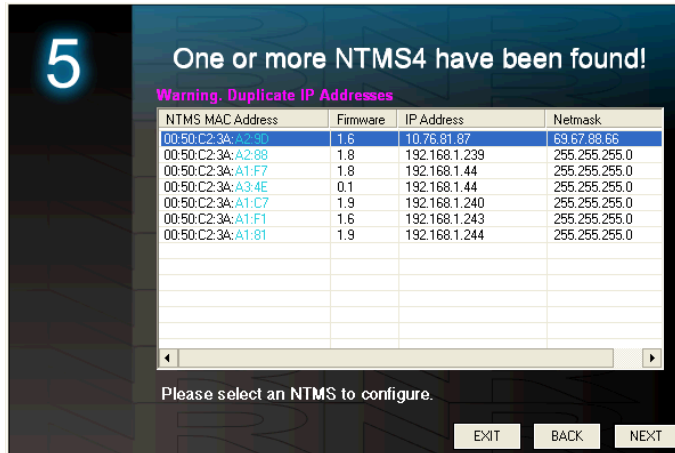

2. Select the NTMS, and proceed to the “NEXT” screen.
3. Enter the correct static IP address and subnet mask for your facility.
4. Click on the NTMS measurement port where the probe is connected, and under the “Device Type” drop down, select the “DCP – Dry Contact Probe” option.

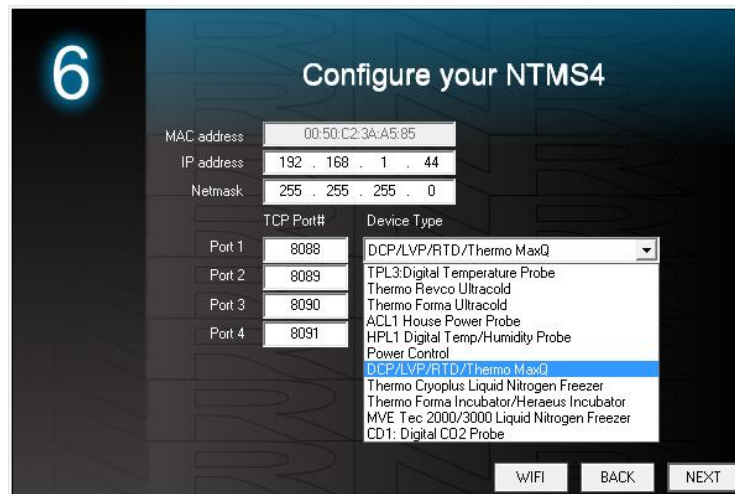

5. Click “NEXT” to complete the NTMS configuration.

3. Testing Data Collection through the Network

Once the configuration is complete we recommend testing the ability to make network measurements by using the “Telnet” utility from any PC. Your DCP must be connected to Networked Robotics’ NTMS network hardware and configured properly to successfully pass this test. Telnet is a commonly-used network utility that sends simple network commands that will elicit a reading from the DCP.

On Windows 7,8, and 10 computers you may need to enable the Telnet utility as follows:
 1 Start 2 Control Panel 3 Programs 4 Turn Windows Features on or off 5 Check “Telnet Client” 6 Hit Ok

1. From Windows access the Command Prompt. On some Windows operating systems you can choose “Start”, “RUN”, enter “CMD” and then return.
2. At the black screen type “Telnet” *IP Port*, where *IP* is the IP address and *Port* is the network port address as selected by your use of the NTMS Configuration Wizard as described above.

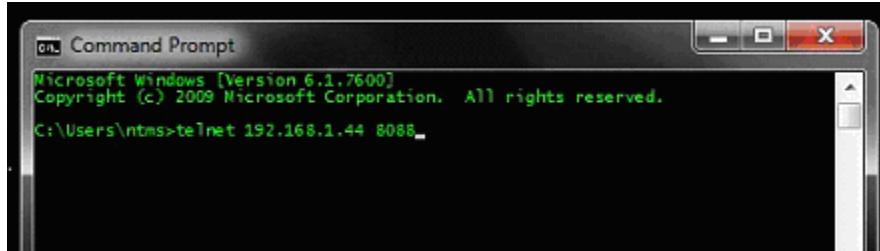

3. If you are successfully connected through the network you will see a blank screen. If you are near the DCP wait for the data acquisition LED, the green LED, to flash.
4. Then type a capital “T” several times repeatedly. “T” is the command character for this interface. The DCP will return a value after a measurement is obtained. Initially the interface may return errors until the first values are obtained.

For more about debugging connections see the appendix of the Tempurity System User’s Guide.

To use your DCP with the Tempurity System, you will need to add the new “monitored device” to the Tempurity Server configuration. See the Tempurity System User’s Guide and the section on server configuration for more information.

Operation

During normal operation, the yellow LED on the DCP will be on, and occasionally blink. The blink indicates it has just been polled for data by the NTMS. If the yellow LED goes out permanently, this is an indication the connection with the NTMS is bad, or that the DCP is connected to an NTMS port which is configured for data collection from some other kind of a monitored device than a “DCP”.

The green LED may be on or off depending on the state of your monitored device (ultracold alarm contacts, cryofreezer, incubator, water sensor etc.). Green LED off indicates “alarm” state. Green LED on indicates “normal” state. Consult the manual for your device to determine if an alarm is indicated by open or closed contacts.

Reference

Unique IDs

All Networked Robotics hardware holds electronically readable globally unique IDs. DCP probe IDs are of the format:

07:0000:0000:0002

Where 7 indicates the product number, and the other characters indicate the electronic ID of the unit. Electronic IDs can be read through using the Networked Robotics “Calibration Programmer” hardware (part number #30010) hardware through a USB connection to a Windows computer.

Electrical Specifications

The DCP derives its power from the regulated 5 volts DC supplied by the NTMS, so no external power supply is required. The DCP determines the state of the dry contacts by applying 5 volts DC at no more than 5 mA.

Communications Specifications

The DCP communicates with the NTMS using RS-232 at 1200bps.

On the NTMS RJ45 jack the pins used are: 4 ground, 5 transmit to the DCP, 6 send from the DCP.

Physical Specifications

Weight:	56 grams (2.0 ounces)
Length:	67.22 mm (2.647 inches)
Width:	66.22 mm (2.607 inches)
Height:	28 mm (1.102 inches)

Support

If you need assistance with your dry contact probe or other products, contact Networked Robotics by phone at 877-FRZ-TEMP (877-379-8367) or by email at support@networkedrobotics.com or visit our web page at <http://www.NetworkedRobotics.com>.

Appendix - Example Alarm Contact Connections

Example 1 - Thermo Scientific® -Revco® Freezer Alarm Contact Connection

Thermo Scientific Revco freezers utilize the following pinout as their alarm contact output. A set of screw terminals is available on the back of the unit. The section on “Physical Installation” above describes how to make the connection to the DCP.

Remote alarm connections 1 Amp Max –Class 2 Circuit Only

Freezer Screw terminals are at the back or side of the unit

Wire	Function
Purple	Common
Black	Open on Fail
Red/White	Close on Fail

For this freezer the alarm contact screw terminals should be connected by connecting pin 2 of the DCP to the purple-wire-connected terminal block of the Revco, connecting pin 1 of the DCP to the black-wire-connected terminal block of the Revco, and pin 3 of the DCP to the red/white wire-connected screw terminal.

Example 2 - Waterbug® Flood Sensor

The Waterbug® by Winland Electronics reports the status of whether water is present and thus can be used as a networked flood sensor when used with the Networked Robotics NTMS, DCP probe, and Tempurity Software.

The Waterbug is an example of a “Form C” Dry contact SPDT sensor.

The Waterbug’s sensor connects to a terminal block. Standard connections are as follows:

V+	Power supply Positive
Gnd	Power supply Ground
S	One wire of the Waterbug sensor (either is ok)
S	The other wire

For use with Tempurity the following connections should be made:

Where the presence of water should be the alarm state:

Connect pin 1 of the DCP to the Waterbug terminal block labeled “NO” for normally open
Connect pin 2 of the DCP to the Waterbug terminal block labeled “C” (for common)
Connect pin 3 of the DCP to the Waterbug terminal block labeled “NC” (for normally closed)

Where the absence of water should be the alarm state:

Connect pin 1 of the DCP to the Waterbug terminal block labeled “NC” for normally closed

Connect pin 2 of the DCP to the Waterbug terminal block labeled “C” (for common)
 Connect pin 3 of the DCP to the Waterbug terminal block labeled “NO” (for normally open)
 Test the DCP-connected sensor by dipping it in water and taking it out. Follow the instructions for testing using the Telnet tool below.

In the Tempurity System Server Configuration Tool Version 2, configure the DCP to a representative indicator, for example type “Water” or type “Flood”. The standard DCP sends -196 as a normal value and 0 as an alarm value, so set your allowed ranges to anything that will consider the -196 as normal and the 0 as an alarm value as shown below. A command character of “T” is the default command character for a DCP.



The screenshot shows the configuration window for a DCP. The fields are as follows:

- Monitored Device Identification:** Name: Flood 2, ID: 2
- Network Source:** IP or Hostname: 192.168.1.44, TCP Port: 8088
- Networked Robotics Hardware ID:** Not available
- Range of Allowed Values:** Minimum Value: -200, Maximum Value: -190
- Alarm Time Thresholds:**
 - Comm Alarm Interval 1: 1 Hour, 0 Min, 0 Sec
 - Comm Alarm Interval 2: 2 Hour, 0 Min, 0 Sec
 - Value Alarm Interval 1: 0 Hour, 10 Min, 0 Sec
 - Value Alarm Interval 2: 0 Hour, 20 Min, 0 Sec
- Monitored Device Type:** Device Type: Custom
- Value Type:** Water
- Value Units:** nunits
- Value Precision:** 0
- Control Character:** T
- Calibration Factor:** 0

Buttons for OK and Cancel are visible at the bottom right.

Value alarm intervals should be short for use with this sensor. This is because this sensor does not “latch” the status and thus the sensor must be continuously flooded for at least 11 minutes in the example value alarm stage 1 threshold of 10 minutes shown above in order for a Stage 1 alarm to be generated. Thus this sensor is better at detecting “pools” of water and when used with Tempurity, may not be able to detect a brief pulse of water running through the sensor. The Waterbug should therefore be mounted in a low spot, or a spot most likely to remain wet during an event.

Example 3 - Door Sensor

The DCP can be used to monitor freezer doors or standard entry doors and windows using 3-pin security system magnetic contacts. To enable this, the DCP is connected to both a normally open, and a normally closed magnetic switch for each door.

The Tempurity System examines door status by default at one minute intervals, and thus cannot detect momentary intrusions. Therefore this application of the DCP is designed to detect long door-open periods that could indicate potential problems in storage environments rather than for human safety or security.

You will need three wires, included with each DCP, to connect the magnetic switch contacts to the DCP. “Common”, “Alarm”, and “Normal” should be connected to corresponding screw terminals on the magnetic switch. Networked Robotics uses Megatronix™ - MGT - Magnetic Reed Switch Sensors which have both Normally Open (N/O) / Normally Closed (N/C) connections in a 3-pin package. These are commonly available from several sources.

Revco® is a registered trademark of Thermo Fisher Scientific Inc. Networked Robotics Corporation is not affiliated with Thermo Fisher Scientific Inc.

Waterbug® is a registered trademark of Winland Electronics, Inc. Networked Robotics Corporation is not affiliated with Winland Electronics.